

Movement Catalogue 2021-2022

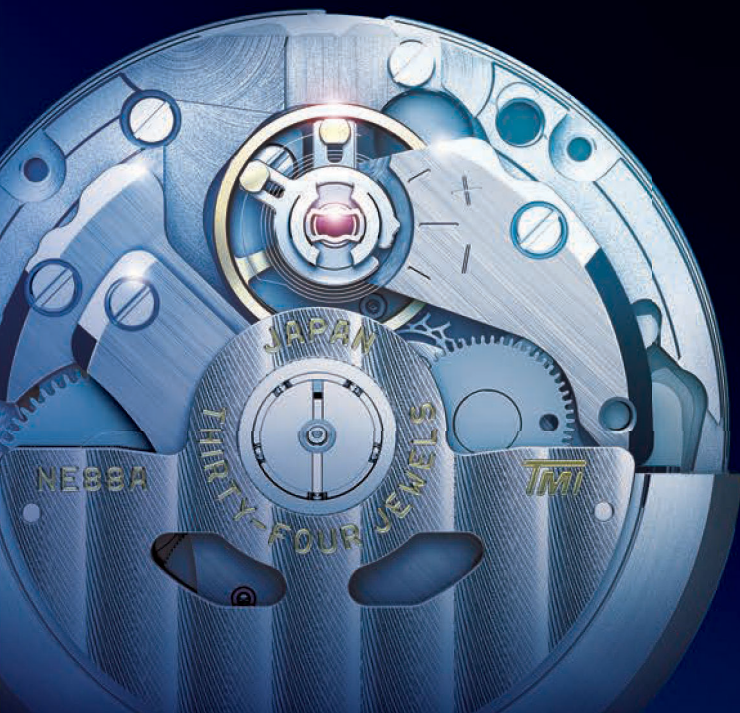

Our Technology

MECHANICAL MOVEMENTS

Precision | Craftsmanship

NE86 & NE88 Mechanical Chronograph

Vertical Clutch



It enhances time measurement accuracy by eliminating the "jumping hand" problem.

"SPRON" Hairspring



SPRON was developed by us as a hairspring material for high-end mechanical movements. It has superior elasticity, durability, and high corrosion and heat resistances.

Column Wheel



It precisely coordinates the chronograph operations.

Three Pointed Hammer



A one-piece component developed by us. It synchronizes all chronograph hands to reset at once (*Instant Zero Reset*).

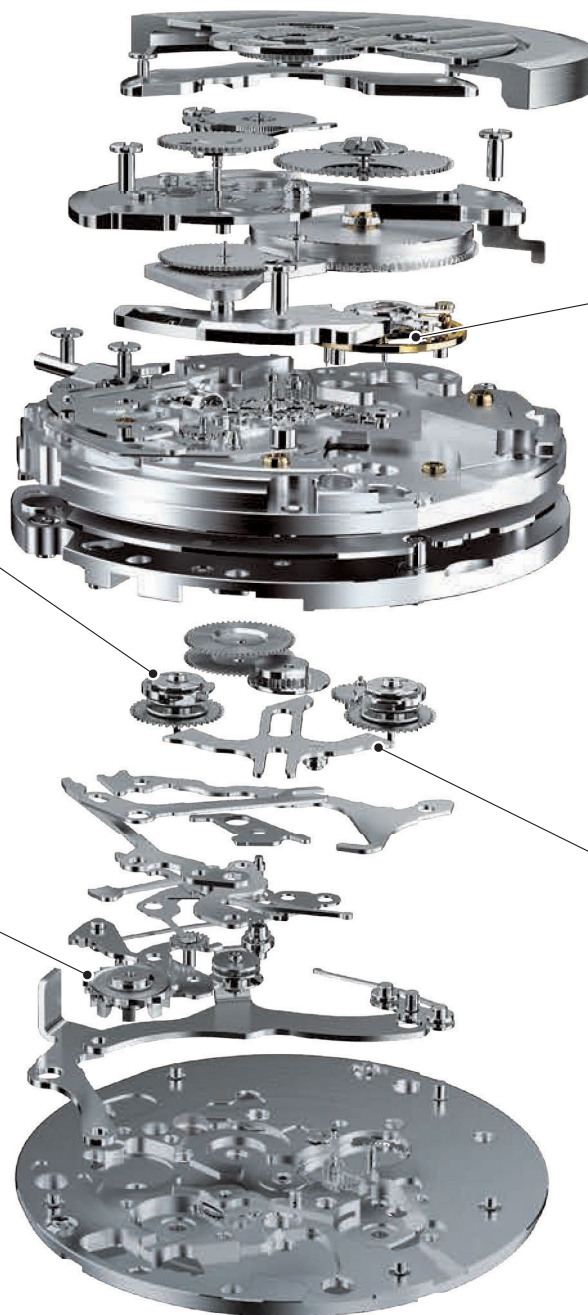

QUARTZ MOVEMENTS

Know-how | Innovation

VH Sweep Second Movement

Motor

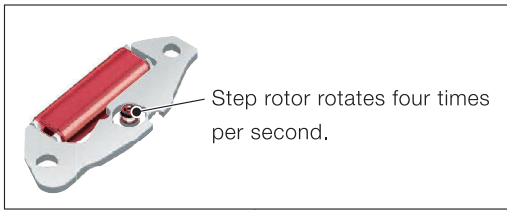

Sweep Second

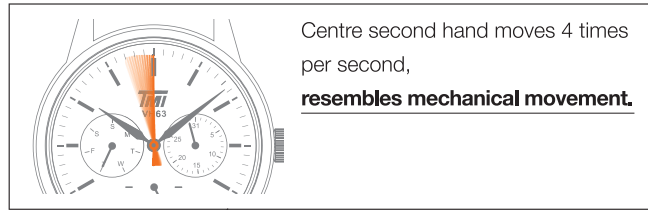

Coil Block

Battery

Quartz Crystal

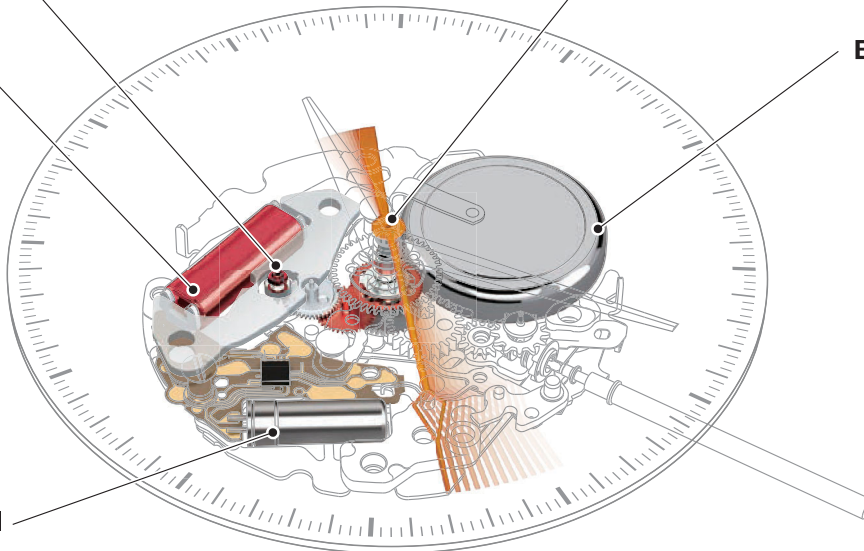

VK Premium Chronograph Movement

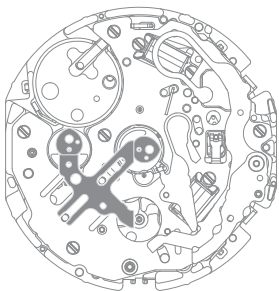

Reset

Instant Zero Reset

VK premium chronograph movements are developed with the Three Pointed Hammer mechanism (once exclusive to our mechanical movements) to achieve the Instant Reset Function, **a signature feature of mechanical chronographs.**

Premium Mechanical Movement

NE86 & NE88 Mechanical Chronograph

- Higher time accuracy
- Duration time: more than 45 hours
- 28,800 vibrations per hour (4Hz)



CASE SIZE (3h-9h)
44mm



Côte de Genève decorated rotor

Mirror Diamond Cut on bridges



Column Wheel
for Chronograph Coordination



Vertical Clutch
for Power Transmission



Three Pointed Hammer
for Instant Zero Reset

NE86 & NE88 Mechanical Chronograph

12½'''

NE86

Height: 7.62mm
Chrono (centre sec, min)
Small second, date
Duration time: more than 45 hours
28,800 vibrations per hour (4Hz)
Stop second device
Quick changing date
34 jewels

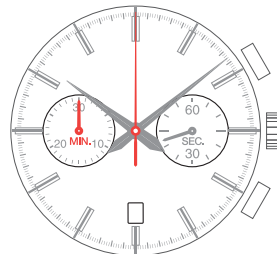

NE88

Height: 7.62mm
Chrono (centre sec, min, hr)
Small second, date
Duration time: more than 45 hours
28,800 vibrations per hour (4Hz)
Stop second device
Quick changing date
34 jewels

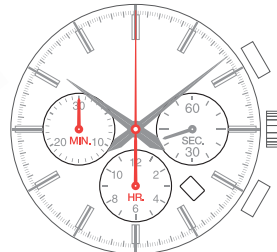

NE57 Power Reserve (Centre-hand)

12'''

NE57
 Height: 6.63mm
 Centre-hand power reserve
 Multi-eye (date)
 Duration time: more than 41 hours
 21,600 vibrations per hour (3Hz)
 Stop second device
 29 jewels

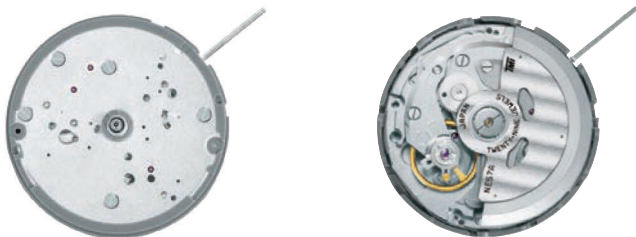

CASE SIZE (3h-9h)
42mm

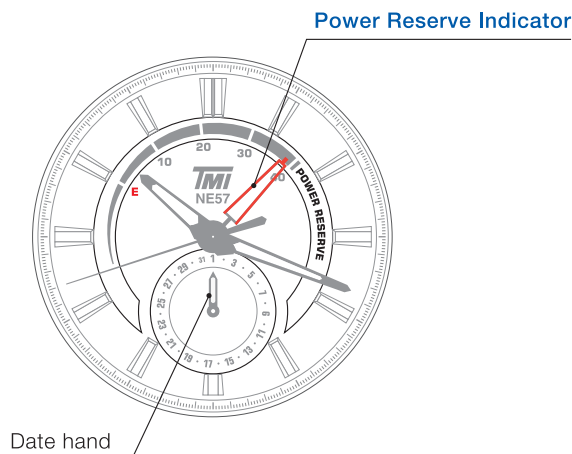

NE20 Power Reserve (Multi-eye)

12'''

NE20
 Height: 6.15mm
 Multi-eye (day, date, power reserve)
 Duration time: more than 45 hours
 28,800 vibrations per hour (4Hz)
 Stop second device
 29 jewels



Power Reserve Indicator

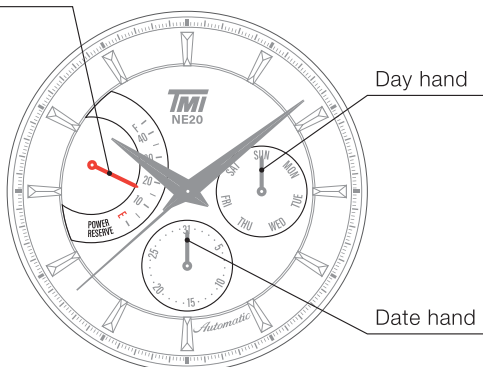

CASE SIZE (3h-9h)
40mm

* Specifications are subject to change without notice. Photos are slightly different from actual products. * Photo Scale = 1:1

Basic Mechanical Movement

NH3 Series High quality features



Mirror finishing (NH38/39)

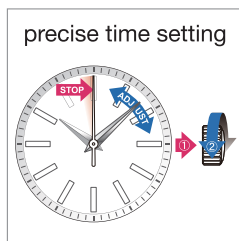

precise time setting
Stop second device



Gold plating (NH38/39)



Côtes de Genève
decorated rotor (optional)



CASE SIZE (3h-9h)
36mm



CASE SIZE (3h-9h)
44mm

NH3 Series

12'''

NH35 
Height: 5.32mm
3 hands / date
21,600 vibrations per hour (3Hz)
Stop second device
24 jewels

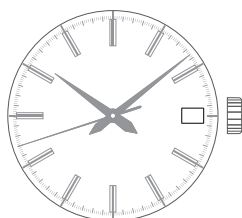

NH36 
Height: 5.32mm
3 hands / day-date
21,600 vibrations per hour (3Hz)
Stop second device
24 jewels

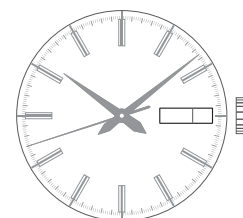

NH37
Height: 5.32mm
3 hands / date, 24 hour
21,600 vibrations per hour (3Hz)
Stop second device
24 jewels

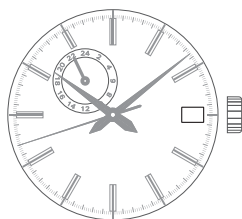

NH38 
Height: 5.32mm
3 hands, open-heart
21,600 vibrations per hour (3Hz)
Stop second device
24 jewels



NH39
Height: 5.32mm
3 hands, 24 hour, open-heart
21,600 vibrations per hour (3Hz)
Stop second device
24 jewels

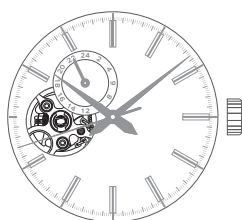

* Specifications are subject to change without notice. Photos are slightly different from actual products. * Photo Scale = 1:1

 High Hand Available

NH0 Series

7 3/4'''

NH05

Height: 5.92mm
3 hands / date
21,600 vibrations per hour (3Hz)
21 jewels

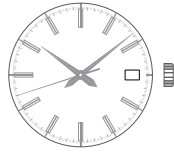

NH06

Height: 5.92mm
3 hands / day-date
21,600 vibrations per hour (3Hz)
21 jewels



NH1 Series

10 1/2'''

NH15

Height: 6.01mm
3 hands / date
21,600 vibrations per hour (3Hz)
21 jewels

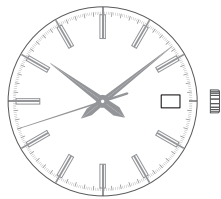

NH16

Height: 6.01mm
3 hands / day-date
21,600 vibrations per hour (3Hz)
21 jewels

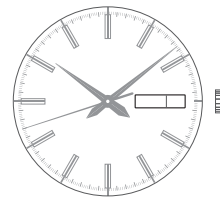

NH7 Series - Skeleton

12'''

NH70

Height: 5.32mm
3 hands
21,600 vibrations per hour (3Hz)
Stop second device
24 jewels
Côtes de Genève decorated rotor
Silver



NH71

Height: 5.32mm
3 hands
21,600 vibrations per hour (3Hz)
Stop second device
24 jewels
Côtes de Genève decorated rotor
Gold

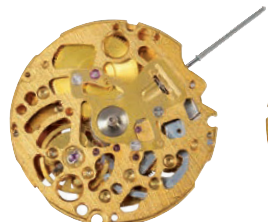

NH72

NEW

Height: 5.32mm
3 hands
21,600 vibrations per hour (3Hz)
Stop second device
24 jewels
Côtes de Genève decorated rotor
Ruthenium Grey

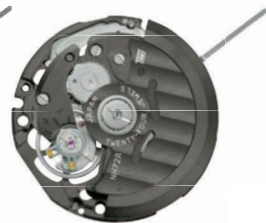
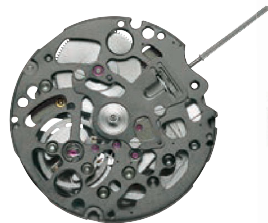

CASE SIZE (3h-9h)
39mm

Premium Chronograph Movement

Quartz Chronograph Mechanical Action



CASE SIZE (3h-9h)
42mm



CASE SIZE (3h-9h)
42mm



Instant Zero Reset of Chrono Hands



Centre 1/5 Chrono Second



Click Feeling Push Buttons

Three Pointed Hammer (Instant zero reset function)

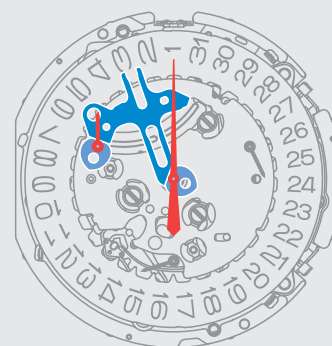

Three pointed hammer has once been exclusive to our mechanical chronographs.

VK premium chronograph series (quartz movements) inherit the technology, setting newly high standard for true chronographs.

VK61 
 Height: 5.10mm
 Chrono (centre 1/5 sec, min)
 Small second, date
 BL: 3 years (SR936SW)

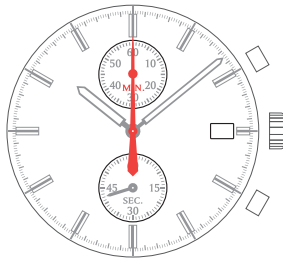

VK64 
 Height: 5.10mm
 Chrono (centre 1/5 sec, min)
 24 hour, date
 BL: 3 years (SR936SW)

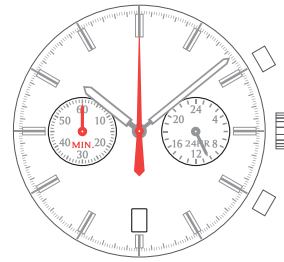

VK63 
 Height: 5.10mm
 Chrono (centre 1/5 sec, min)
 24 hour, small second, date
 BL: 3 years (SR936SW)

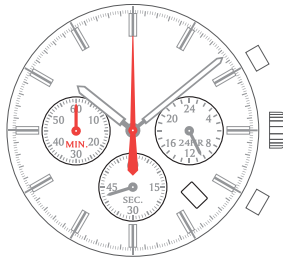

VK67 
 Height: 5.10mm
 Chrono (centre 1/5 sec, min, hr)
 Small second, date
 BL: 3 years (SR936SW)

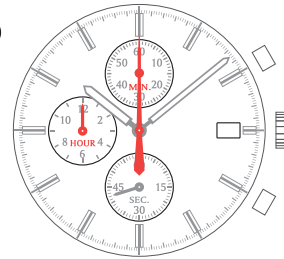

VK68 
 Height: 5.10mm
 Chrono (centre 1/5 sec, min)
 24 hour, small second, date
 BL: 3 years (SR936SW)

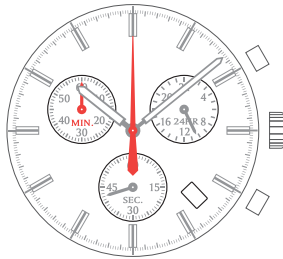

VK83 
 Height: 5.10mm
 Chrono (centre 1/5 sec, min)
 24 hour, small second, date
 BL: 3 years (SR936SW)

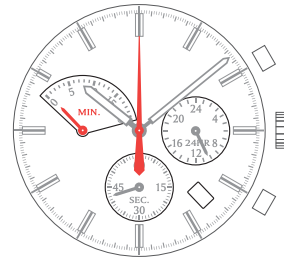

VK73 
 Height: 5.90mm
 Chrono (centre 1/5 sec, min)
 24 hour, small second, date
 BL: 3 years (SR936SW)
BIG Calendar

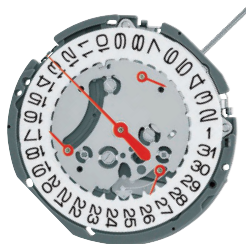
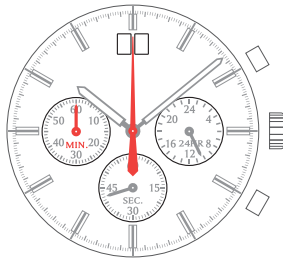

VK68

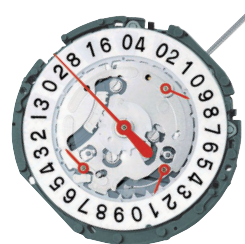

VK73

Basic Chronograph Movement

Strong Hand Torque

(measure : unbalance weight)

| | |
|-------------|----------|
| Hour hand | 0.60μN·m |
| Minute hand | 0.90μN·m |
| Second hand | 0.09μN·m |

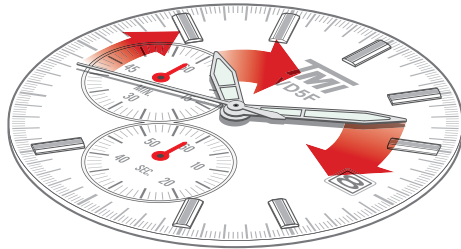

NEW
VD5F

CASE SIZE (3h-9h)
44mm

Super High Hand

VD53 Unit : 1/100mm

Type LLA

Type LLB

* Dimensions in () are for reference only.

VD57 Unit : 1/100mm

Type LLA

Type LLB

* Dimensions in () are for reference only.



CASE SIZE (3h-9h)
40mm



CASE SIZE (3h-9h)
42mm

VD5 Series

Strong Hand Torque



3-Year Battery Life

12^{3/4}"

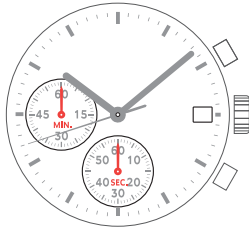

VD5F   **NEW**

Height: 4.57mm
Chrono (sec, 60 min)
Date
BL: 3 years (SR920SW)



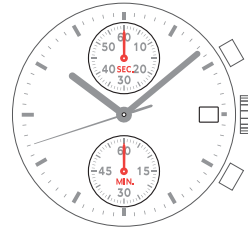

VD51  
Height: 4.57mm
Chrono (sec, 60 min)
Date
BL: 3 years (SR920SW)

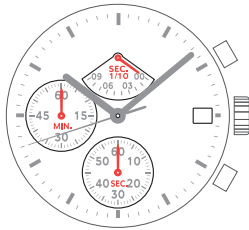

VD50  
Height: 4.57mm
Chrono (1/10 sec, sec, 60 min)
Date
BL: 3 years (SR920SW)



VD52  
Height: 4.57mm
Chrono (sec, 60 min)
24 hour, date
BL: 3 years (SR920SW)

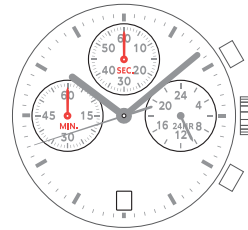

VD54 
Height: 3.97mm
Chrono (sec, 60 min)
24 hour
BL: 3 years (SR920SW)

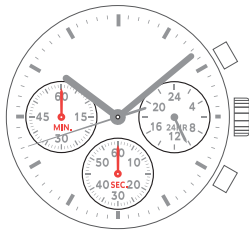

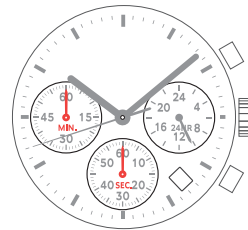

VD53  
Height: 4.57mm
Chrono (sec, 60 min)
24 hour, date
BL: 3 years (SR920SW)
Super High Hand

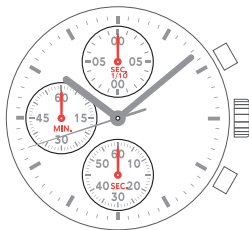

VD55 
Height: 3.97mm
Chrono (1/10 sec, sec, 60 min)
BL: 3 years (SR920SW)



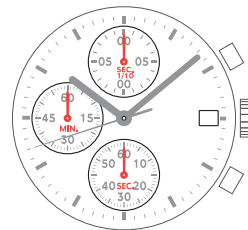

VD57  
Height: 4.57mm
Chrono (1/10 sec, sec, 60 min)
Date
BL: 3 years (SR920SW)
Super High Hand

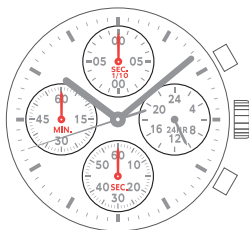

VD56 
Height: 3.97mm
Chrono (1/10 sec, sec, 60 min)
24 hour
BL: 3 years (SR920SW)



VD59  
Height: 4.57mm
Chrono (1/10 sec, sec, 60 min)
Sun & moon
BL: 3 years (SR920SW)

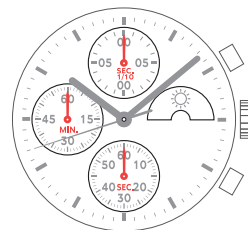

* Specifications are subject to change without notice. Photos are slightly different from actual products. * Photo Scale = 1:1 BL = Battery Life

 High Hand Available  Long Stem Available

 Super High Hand  Super High Hand Option Available.

Dual Time Movement

Strong Hand Torque Dual Time Movement with Pushers



CASE SIZE (3h-9h)
42mm

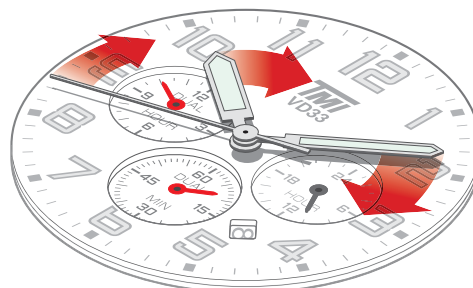

(measure : unbalance weight)

| | |
|-------------|----------------|
| Hour hand | 0.60 μ N·m |
| Minute hand | 0.90 μ N·m |
| Second hand | 0.09 μ N·m |

2nd Time Zone Indication



London
01:08 AM



Tokyo
10:08 AM



New York
08:08 PM

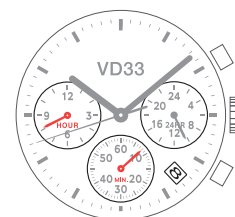

Compatible with VD5 Basic Chronograph Movements

VD3 Series

Strong Hand Torque

⚡ 3-Year Battery Life

12³/₄"

VD31 HL
 Height: 4.57mm
 Dual time
 Local time: 3 hands, 24 hr, date
 2nd time: 24 hr
 BL: 3 years (SR920SW)

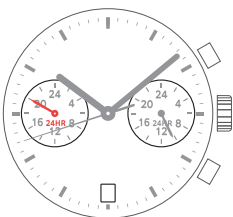

VD32 H
 Height: 3.97mm
 Dual time
 Local time: 3 hands, 24 hr
 2nd time: 24 hr
 BL: 3 years (SR920SW)

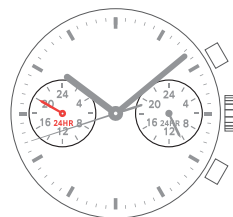

VD33 HL
 Height: 4.57mm
 Dual time
 Local time: 3 hands, 24 hr, date
 2nd time: 12 hr, min
 BL: 3 years (SR920SW)

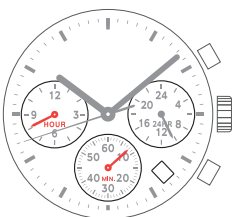

VD34 H
 Height: 3.97mm
 Dual time
 Local time: 3 hands, 24 hr
 2nd time: 12 hr, min
 BL: 3 years (SR920SW)

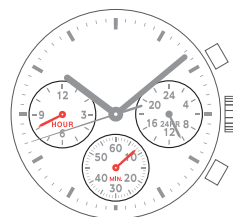

VD35 HL
 Height: 4.57mm
 Dual time
 Local time: 3 hands, date
 2nd time: 24 hr, min
 BL: 3 years (SR920SW)

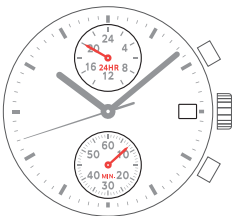

VD36 H
 Height: 3.97mm
 Dual time
 Local time: 3 hands
 2nd time: 24 hr, min
 BL: 3 years (SR920SW)

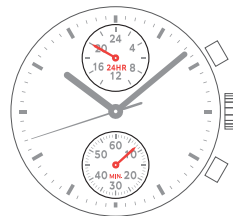

VD37 HL
 Height: 4.57mm
 Dual time
 Local time: 3 hands, date
 2nd time: 12 hr, 24 hr, min
 BL: 3 years (SR920SW)

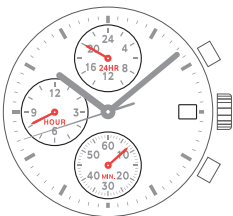

VD38 H
 Height: 3.97mm
 Dual time
 Local time: 3 hands
 2nd time: 12 hr, 24 hr, min
 BL: 3 years (SR920SW)

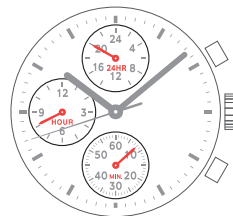

CASE SIZE (3h-9h)
40mm



CASE SIZE (3h-9h)
44mm

* Specifications are subject to change without notice. Photos are slightly different from actual products. * Photo Scale = 1:1 BL = Battery Life

H High Hand Available L Long Stem Available

Sweep Second Movement

Hand Height Combination: Type LA

NEW



CASE SIZE (3h-9h)
40mm

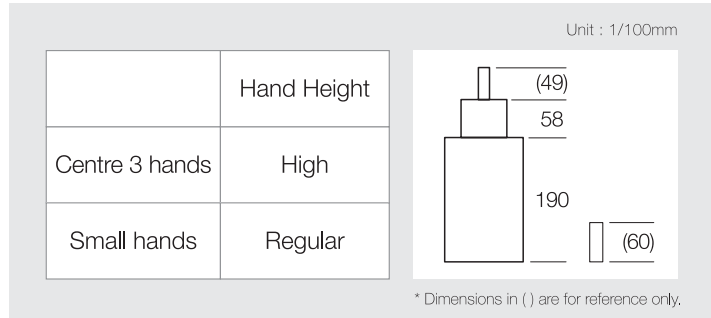

Available For VH60 and VH63

Sweep Second

Centre second hand moves 4 times per second resembles mechanical movement.



Strong Hand Torque (measure : unbalance weight)

| | Common Quartz | VH Series | Common Quartz vs VH Series | |
|-------------|----------------|----------------|----------------------------|---------------|
| Second hand | 0.07 μ N·m | 0.30 μ N·m | | About 400% Up |
| Small hand | 0.05 μ N·m | 0.10 μ N·m | | About 200% Up |

internal product comparison



CASE SIZE (3h-9h)
36mm



CASE SIZE (3h-9h)
40mm



CASE SIZE (3h-9h)
43mm

VH60 HL
 Height: 3.45mm
 Sweep second
 Multi-eye (24 hr)
 BL: 2 years (SR920SW)
Type LA

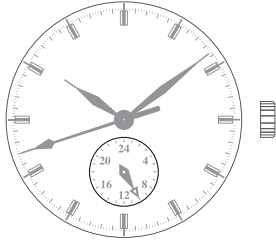

VH65 HL
 Height: 3.45mm
 Sweep second
 Multi-eye (date)
 BL: 2 years (SR920SW)

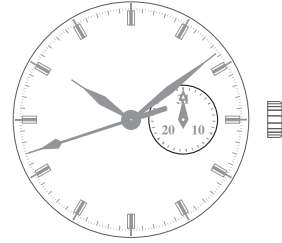

VH61 HL
 Height: 3.45mm
 Sweep second
 Multi-eye (date, 24 hr)
 BL: 2 years (SR920SW)
Type S

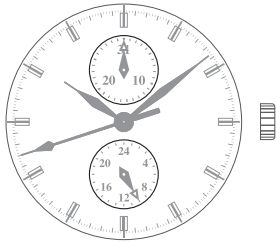

VH64 HL
 Height: 3.45mm
 Sweep second
 Multi-eye (day, date)
 BL: 2 years (SR920SW)
Type S

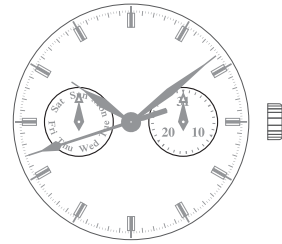

VH63 HL
 Height: 3.45mm
 Sweep second
 Multi-eye (day, date, 24 hr)
 BL: 2 years (SR920SW)
Type LA Type S

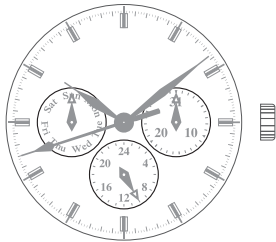

VH67 HL
 Height: 3.45mm
 Sweep second
 Multi-eye (day, date, 24 hr)
 BL: 2 years (SR920SW)
Type S

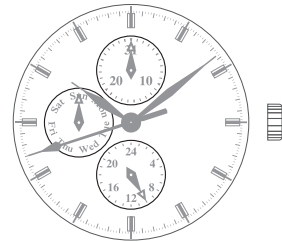

VH68 HL
 Height: 3.45mm
 Sweep second
 Multi-eye (day, date, 24 hr)
 BL: 2 years (SR920SW)

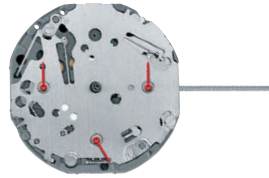
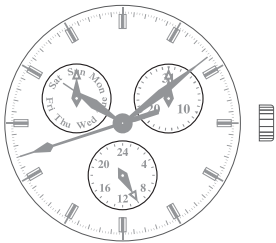

VH63

VH83 HL
 Height: 3.45mm
 Sweep second
 Multi-eye (day, date, 24 hr)
 BL: 2 years (SR920SW)

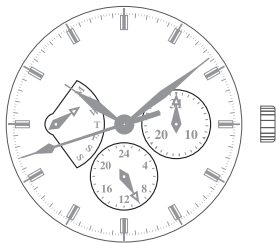

VH88 HL
 Height: 3.45mm
 Sweep second
 Multi-eye (day, date, 24 hr)
 BL: 2 years (SR920SW)

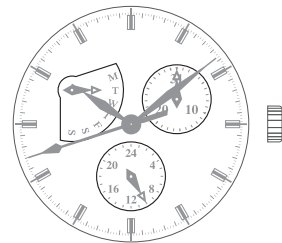

VH31 HL
 Height: 3.45mm
 Sweep second
 3 hands
 BL: 2 years (SR920SW)

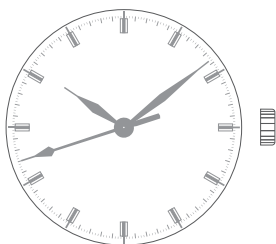

* Specifications are subject to change without notice. Photos are slightly different from actual products. * Photo Scale = 1:1 BL = Battery Life

H High Hand Available L Long Stem Available

2 Hands Multi-eye Movement

Minimal · Balanced · Variety



CASE SIZE (3h-9h)
38.6mm

2 hands at Centre

Balanced Layout

a : 7.5mm
b : 6.9mm

All 13 calibres are case compatible

High Hand Available



CASE SIZE (3h-9h)
29mm



CASE SIZE (3h-9h)
38mm





CASE SIZE (3h-9h)
42mm

VD7 Series

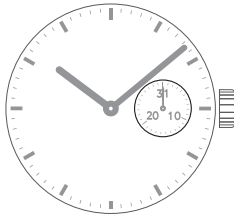

10 1/2'''

VD70  
 Height: 3.45mm
 Multi-eye (date)
 BL: 3 years (SR626SW)



VD72  
 Height: 3.45mm
 Multi-eye (date)
 BL: 3 years (SR626SW)



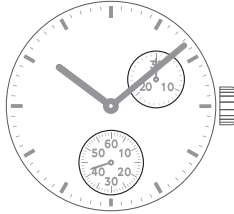

VD73  
 Height: 3.45mm
 Multi-eye (date, small sec)
 BL: 3 years (SR626SW)





VD74  
 Height: 3.45mm
 Multi-eye (day, date, 24 hr, small sec)
 BL: 3 years (SR626SW)



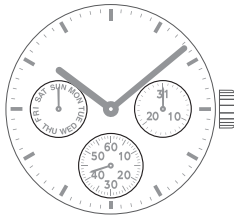

VD75  
 Height: 3.45mm
 Multi-eye (day, date, small sec)
 BL: 3 years (SR626SW)



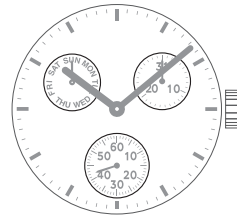

VD76  
 Height: 3.45mm
 Multi-eye (day, date, small sec)
 BL: 3 years (SR626SW)





VD77  
 Height: 3.45mm
 Multi-eye (24 hr, small sec)
 BL: 3 years (SR626SW)



VD78  
 Height: 3.45mm
 Multi-eye (small sec)
 BL: 3 years (SR626SW)





VD79  
 Height: 3.45mm
 Multi-eye (day, date)
 BL: 3 years (SR626SW)





VD8 Series

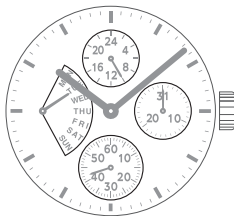

10 1/2'''

VD84  
 Height: 3.45mm
 Multi-eye (day, date, 24 hr, small sec)
 BL: 3 years (SR626SW)



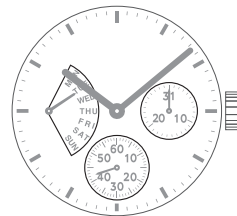

VD85  
 Height: 3.45mm
 Multi-eye (day, date, small sec)
 BL: 3 years (SR626SW)

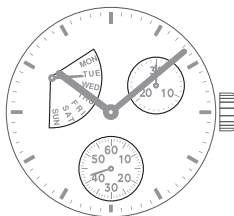

VD86  
 Height: 3.45mm
 Multi-eye (day, date, small sec)
 BL: 3 years (SR626SW)



VD87  
 Height: 3.45mm
 Multi-eye (day, date, small sec)
 BL: 3 years (SR626SW)

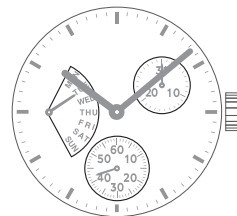

* Specifications are subject to change without notice. Photos are slightly different from actual products. * Photo Scale = 1:1 BL = Battery Life

 High Hand Available  Long Stem Available

Slim / Small Movement

VJ & VC Series



Slim · Variety

- Sizes from 4 3/4" to 12 1/2"
- Calendars in different languages, colors, positions and shapes
- High hand and long stem versions available
- 3-year battery



2 Hands



3 Hands

3-Year Battery Life

4 3/4"

VC00
Height: 2.38mm
BL: 3 years (SR521SW)



VC01
Height: 2.38mm
BL: 3 years (SR521SW)



5 1/2"

VC10
Height: 2.38mm
BL: 3 years (SR521SW)



VC11
Height: 2.38mm
BL: 3 years (SR521SW)



CASE SIZE (3h-9h)
22mm



CASE SIZE (3h-9h)
22.5mm



2 Hands



3 Hands



2 Hands / Date



3 Hands / Date



3 Hands / Day-Date

VJ20 Height: 2.28mm
BL: 3 years (SR621SW)

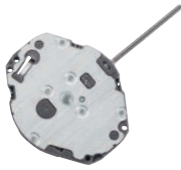

VJ21 Height: 2.28mm
BL: 3 years (SR621SW)



VJ24 Height: 2.71mm
BL: 3 years (SR621SW)



VJ22 Height: 2.71mm
BL: 3 years (SR621SW)



VJ23 Height: 2.94mm
BL: 3 years (SR621SW)



6³/₄"



CASE SIZE (3h-9h)
40mm

VJ14 Height: 2.71mm
BL: 3 years (SR621SW)



VJ12 Height: 2.71mm
BL: 3 years (SR621SW)



8³/₄"

VJ34 Height: 2.71mm
BL: 3 years (SR621SW)

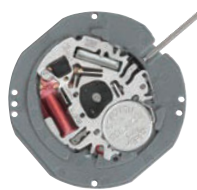

VJ32 Height: 2.71mm
BL: 3 years (SR621SW)



VJ33 Height: 2.94mm
BL: 3 years (SR621SW)



10¹/₂"



3 Hands / Date



3 Hands / Day-Date



3 Hands / Wide Day-Date



3 Hands / Big Calendar

VJ42 Height: 2.71mm
BL: 3 years (SR621SW)



VJ43 Height: 2.94mm
BL: 3 years (SR621SW)



VJ45 Height: 2.94mm
BL: 3 years (SR621SW)



VJ76 Height: 3.50mm
BL: 3 years (SR621SW)
[BIG Calendar](#)



11¹/₂"

VJ52 Height: 2.71mm
BL: 3 years (SR621SW)



VJ53 Height: 2.94mm
BL: 3 years (SR621SW)



VJ55 Height: 2.94mm
BL: 3 years (SR621SW)



Trapezium shape window is available for VJ42 / VJ52

| | |
|------|---|
| VJ42 | W = 410 H ₁ = 145, H ₂ = 225 |
| VJ52 | W = 450 H ₁ = 160, H ₂ = 250 |

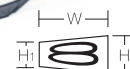

* Unit : 1/100mm

* Specifications are subject to change without notice. Photos are slightly different from actual products. * Photo Scale = 1:1 BL = Battery Life
 High Hand Available Long Stem Available

Standard Movement



2 Hands



3 Hands



3 Hands / Date



3 Hands / Day-Date



3 Hands / Sun & Moon

5 1/2'''

PC10
Height: 3.15mm
BL: 2 years (SR527SW)



PC11
Height: 3.15mm
BL: 2 years (SR527SW)

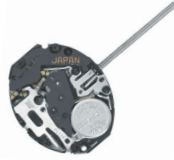

6 3/4 x 8'''

PC21AE / AF
Height: 3.15mm
BL: 2 years (SR626SW)

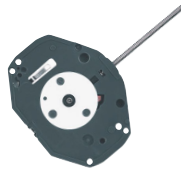

PC21J
Height: 3.15mm
BL: 3 years (SR626SW)

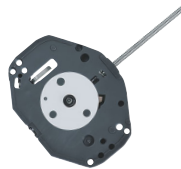

PC22
Height: 4.15mm
BL: 3 years (SR626SW)



PC23
Height: 4.15mm
BL: 3 years (SR626SW)



PC29
Height: 4.15mm
BL: 3 years (SR626SW)



10 1/2'''

PC32
Height: 4.15mm
BL: 3 years (SR626SW)



PC33
Height: 4.15mm
BL: 3 years (SR626SW)



PC39
Height: 4.15mm
BL: 3 years (SR626SW)



Our PC21 movement with gold "JAPAN" marking indicates that it is "Made In JAPAN"



RoHS compliant

Grey color

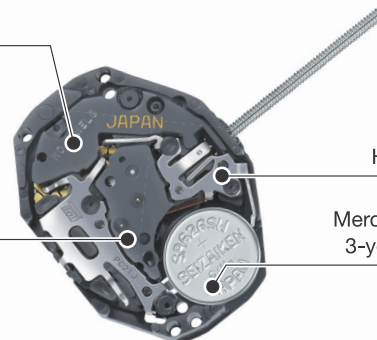

High accuracy

Mercury / lead free
3-year life battery

Care for **Quality** | Care for **Nature**

We pursue a better environment by removing the hazardous mercury and lead from all movements' batteries since 2008.

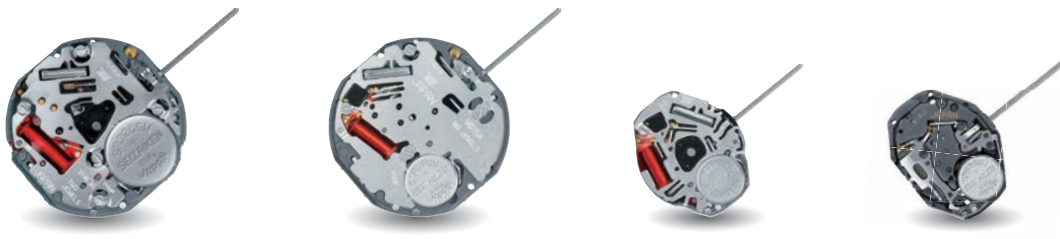

Japan factory in Morioka



FA(Factory Automation) line of AQ movements in factory



Japan head office

Hand Height Options

Basic Mechanical Movement

| NH35 / NH36 / NH38 / NH70 / NH71 / NH72 | | NH37 / NH39 |
|---|---|-------------|
| M | L | M |
| | | |

Premium Chronograph Movement

| VK61 / VK63 / VK64 / VK67 / VK68 / VK83 | | VK73 | |
|---|----|------|---|
| L | LL | M | L |
| | | | |

Basic Chronograph Movement

| VD5 Series | | | |
|------------|---|-----|-----|
| M | L | LLA | LLB |
| | | | |

Sweep Second Movement

| VH6 Series / VH8 Series | | | | VH31 | |
|-------------------------|---|---|----|------|---|
| S | M | L | LA | M | L |
| | | | | | |

* Dimensions in () are for reference only. * Unit : 1/100mm

Remarks

Type M : Regular Production (Stock Item)

Others : Order Based Production (Please contact us for more details)

Dual Time Movement

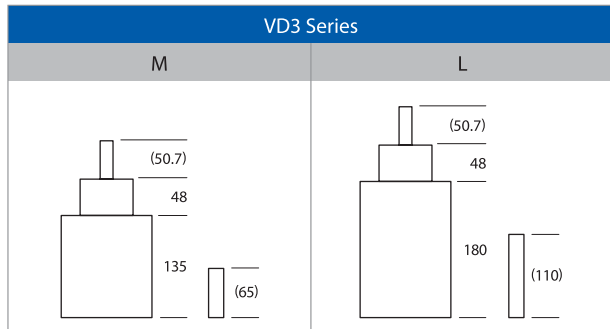

2 Hands Multi-eye Movement

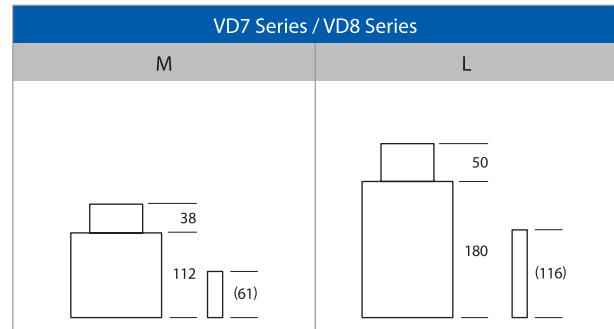

Slim / Small Movement

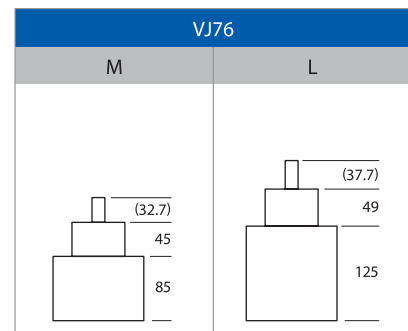
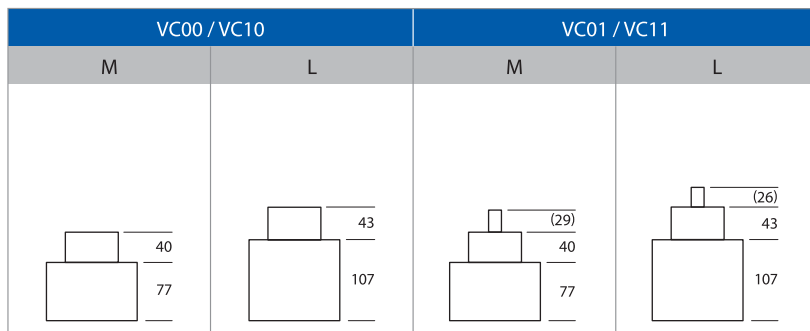

Slim / Small Movement

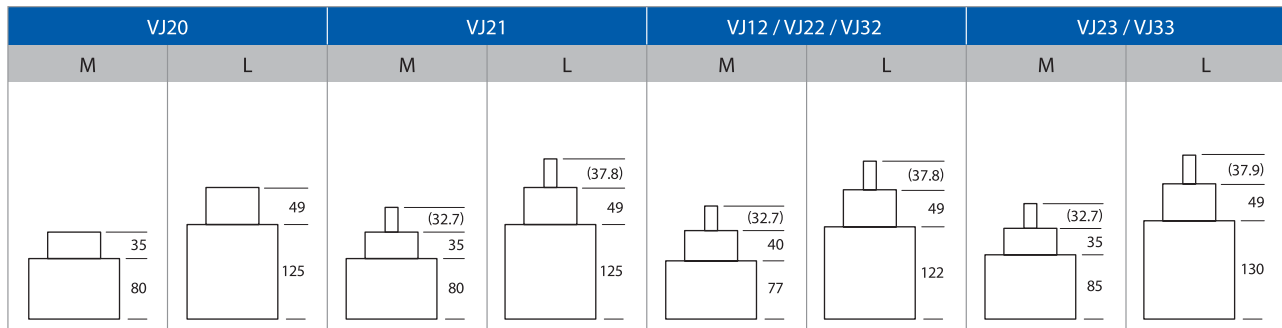

Standard Movement

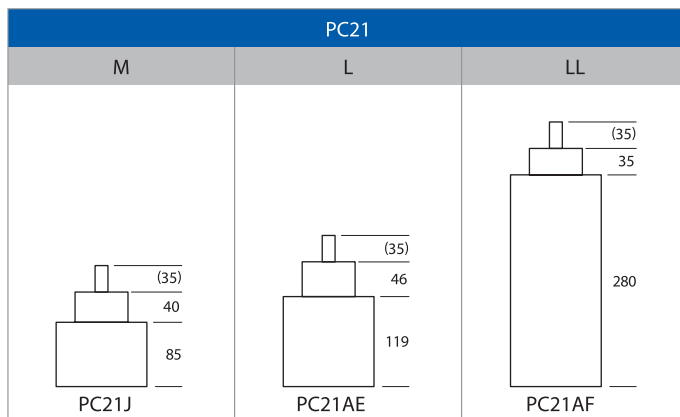

* PC21J : 3 years battery life
PC21AE / AF : 2 years battery life

Stem Length Options

Remarks



Standard Stem : Regular Production (Stock Item)

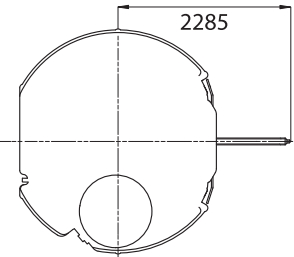
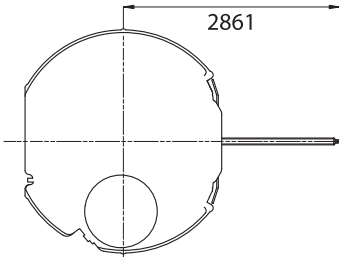
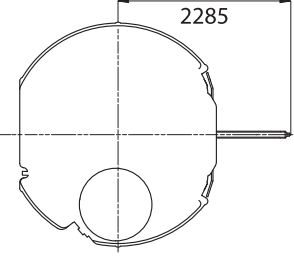
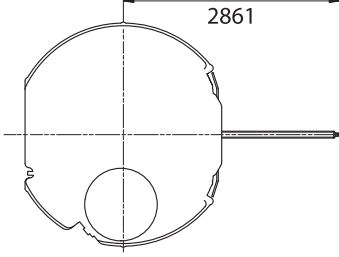
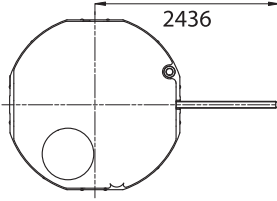
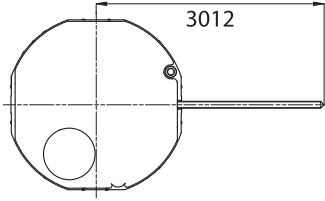
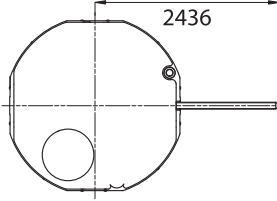
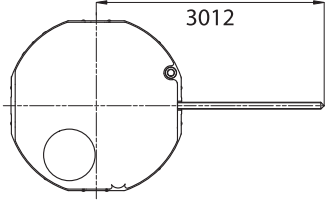
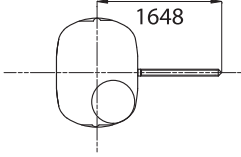
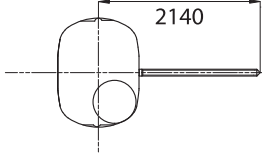
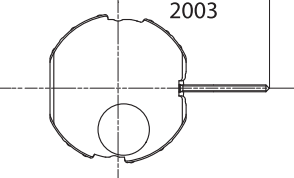
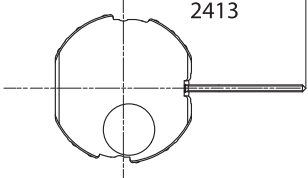
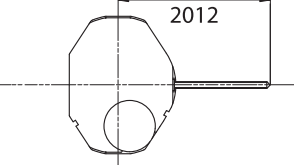
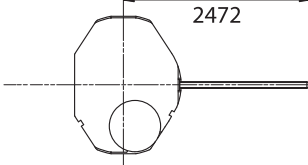



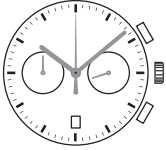
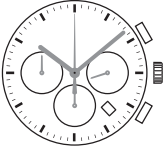

Long Stem : Order Based Production (Please contact us for more details)

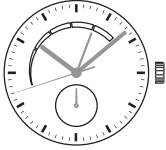
| VD5F /VD50 /VD51 /VD52 /VD53 /VD57 /VD59 | Standard | Long |
|--|---|---|
| |  |  |
| VD31 /VD33 /VD35 /VD37 | Standard | Long |
| |  |  |
| VH Series | Standard | Long |
| |  |  |
| VD7 Series /VD8 Series | Standard | Long |
| |  |  |
| VC Series | Standard | Long |
| |  |  |
| VJ12 /VJ14 /VJ22 /VJ23 /VJ24 /VJ32 /VJ33 /VJ34 | Standard | Long |
| |  |  |
| PC21J | Standard | Long |
| |  |  |

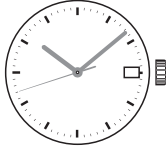
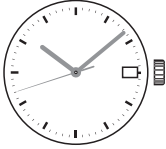
* Unit : 1/100mm

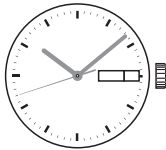
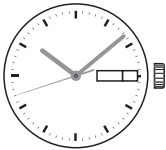
Mechanical Movements – Index

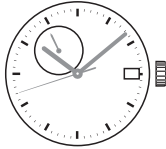
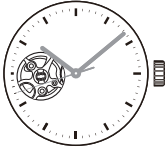
| Premium Mechanical Movement | | | | |
|-----------------------------|---|---|--|---|
| Chronograph | NE86 12½" | NE88 12½" | NE20 12" | NE57 12" |
| |  |  |  |  |
| | Height : 7.62 mm | Height : 7.62 mm | Height : 6.15 mm | Height : 6.63 mm |
| | | | | |

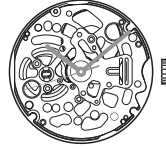
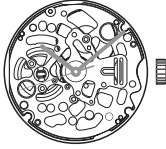

| Basic Mechanical Movement | | | | |
|---------------------------|---|---|--|--|
| Date | NH05 7¾" | NH15 10½" | NH35 H 12" |  |
| | Height : 5.92 mm |  | Height : 6.01 mm |  |
| Day - Date | NH06 7¾" | NH16 10½" | NH36 H 12" |  |
| | Height : 5.92 mm |  | Height : 6.01 mm |  |
| Function | NH37 12" | NH38 H 12" | NH39 12" |  |
| | Height : 5.32 mm |  | Height : 5.32 mm |  |
| Skeleton | NH70 H 12" | Silver NH71 H 12" | Gilt NH72 H NEW 12" | Ruthenium grey  |
| | Height : 5.32 mm |  | Height : 5.32 mm | Height : 5.32 mm |

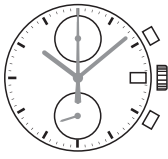
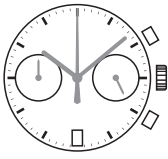
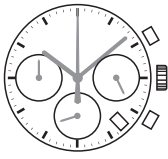
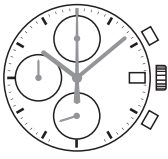
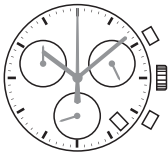
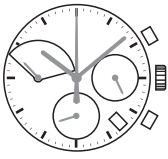
Quartz Movements – Index

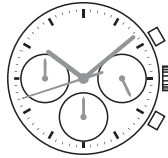
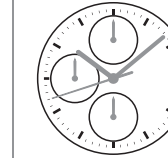
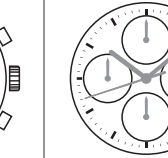
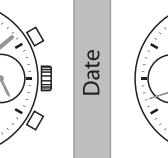
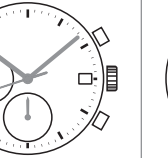
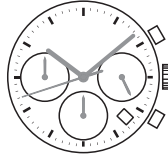
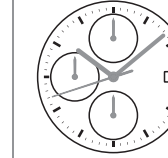
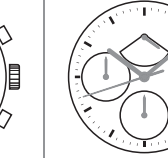
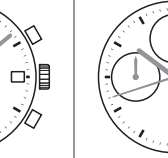
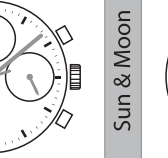

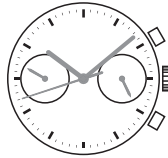
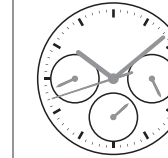
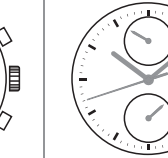
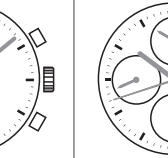
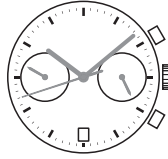
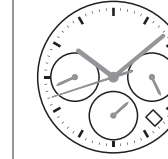
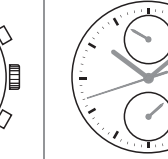
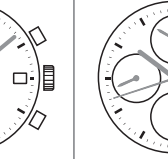

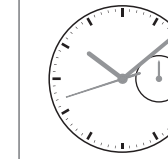
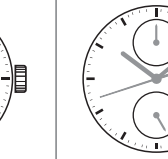
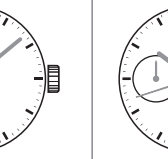
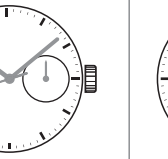
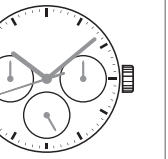

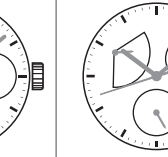
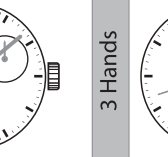

























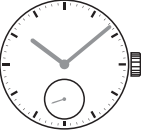





| Premium Chronograph Movement | | | | | | | BL : 3 years |
|------------------------------|---|---|---|---|--|---|--|
| Date | VK61 H 13 1/2" | VK64 H 13 1/2" | VK63 H 13 1/2" | VK67 H 13 1/2" | VK68 H 13 1/2" | VK83 H 13 1/2" | Big Calendar VK73 H 13 1/2" |
| |  |  |  |  |  |  | |
| | Height : 5.10 mm | Height : 5.10 mm | Height : 5.10 mm | Height : 5.10 mm | Height : 5.10 mm | Height : 5.10 mm | Height : 5.90 mm |

| Basic Chronograph Movement | | | | | | BL : 3 years |
|----------------------------|---|---|---|---|--|--------------|
| No Date | VD54 H 12 3/4" | VD55 H 12 3/4" | VD56 H 12 3/4" | VD5F H L NEW 12 3/4" | VD51 H L 12 3/4" | Date |
| |  |  |  |  |  | |
| | Height : 3.97 mm | Height : 3.97 mm | Height : 3.97 mm | Height : 4.57 mm | Height : 4.57 mm | |
| Date | VD53 H L 12 3/4" | VD57 H L 12 3/4" | VD50 H L 12 3/4" | VD52 H L 12 3/4" | VD59 H L 12 3/4" | Sun & Moon |
| |  |  |  |  |  | |
| | Height : 4.57 mm | Height : 4.57 mm | Height : 4.57 mm | Height : 4.57 mm | Height : 4.57 mm | |















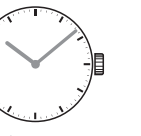

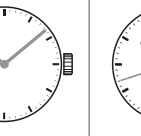

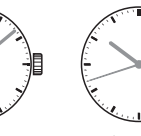

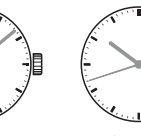





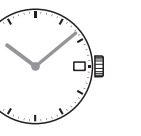

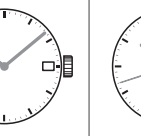

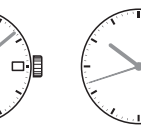

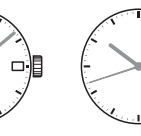

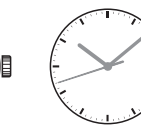



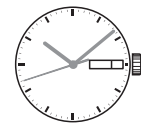

| Dual Time Movement | | | | BL : 3 years |
|--------------------|---|---|---|---|
| No Date | VD32 H 12 3/4" | VD34 H 12 3/4" | VD36 H 12 3/4" | VD38 H 12 3/4" |
| |  |  |  |  |
| | Height : 3.97 mm | Height : 3.97 mm | Height : 3.97 mm | Height : 3.97 mm |
| Date | VD31 H L 12 3/4" | VD33 H L 12 3/4" | VD35 H L 12 3/4" | VD37 H L 12 3/4" |
| |  |  |  |  |
| | Height : 4.57 mm | Height : 4.57 mm | Height : 4.57 mm | Height : 4.57 mm |

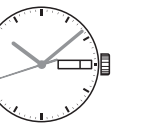
| Sweep Second Movement | | | | | | BL : 2 years |
|-----------------------|---|---|---|---|--|---|
| Multi-eye | VH60 H L 10 1/2" | VH65 H L 10 1/2" | VH61 H L 10 1/2" | VH64 H L 10 1/2" | VH63 H L 10 1/2" | VH67 H L 10 1/2" |
| |  |  |  |  |  |  |
| | Height : 3.45 mm | Height : 3.45 mm | Height : 3.45 mm | Height : 3.45 mm | Height : 3.45 mm | Height : 3.45 mm |
| Retrograde | VH68 H L 10 1/2" | VH83 H L 10 1/2" | VH88 H L 10 1/2" | VH31 H L 10 1/2" | | |
| |  |  |  |  | | |
| | Height : 3.45 mm | Height : 3.45 mm | Height : 3.45 mm | Height : 3.45 mm | | |

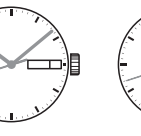

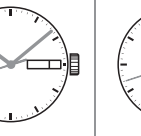

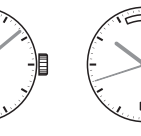

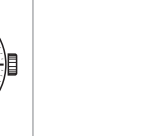



2 Hands Multi-eye Movement BL : 3 years

| | | | | | | | |
|-----------|--|--|--|--|---|--|--|
| Multi-eye | VD70   10 1/2"  Height : 3.45 mm | VD72   10 1/2"  Height : 3.45 mm | VD73   10 1/2"  Height : 3.45 mm | VD74   10 1/2"  Height : 3.45 mm | VD75   10 1/2"  Height : 3.45 mm | VD76   10 1/2"  Height : 3.45 mm | VD77   10 1/2"  Height : 3.45 mm |
| | VD78   10 1/2"  Height : 3.45 mm | VD79   10 1/2"  Height : 3.45 mm | Retrograde | VD84   10 1/2"  Height : 3.45 mm | VD85   10 1/2"  Height : 3.45 mm | VD86   10 1/2"  Height : 3.45 mm | VD87   10 1/2"  Height : 3.45 mm |

Slim / Small Movement BL : 3 years

| | | | | | | | | |
|-------------------|---|---|---|--|--|---|---|--|
| 2 Hands / 3 Hands | VC00   4 3/4"  Height : 2.38 mm | VC10   5 1/2"  Height : 2.38 mm | VJ20  6 3/4x8"  Height : 2.28 mm | VC01   4 3/4"  Height : 2.38 mm | VC11   5 1/2"  Height : 2.38 mm | VJ21  6 3/4x8"  Height : 2.28 mm | | |
| | Date | VJ24  6 3/4x8"  Height : 2.71 mm | VJ14  8 3/4"  Height : 2.71 mm | VJ34  10 1/2"  Height : 2.71 mm | VJ22   6 3/4x8"  Height : 2.71 mm | VJ12   8 3/4"  Height : 2.71 mm | VJ32   10 1/2"  Height : 2.71 mm | VJ42  11 1/2"  Height : 2.71 mm |
| Big Calendar | VJ76  11 1/2"  Height : 3.50 mm | Day - Date | VJ23   6 3/4x8"  Height : 2.94 mm | VJ33   10 1/2"  Height : 2.94 mm | VJ43  11 1/2"  Height : 2.94 mm | VJ53  12 1/2"  Height : 2.94 mm | VJ45  11 1/2"  Height : 2.94 mm | VJ55  12 1/2"  Height : 2.94 mm |

Standard Movement BL : 2 years/ 3 years

| | | | | | | | | |
|-------------------|---|---|--|--|---|--|------------|---|
| 2 Hands / 3 Hands | PC10 5 1/2"  Height : 3.15 mm BL : 2 years | PC11 5 1/2"  Height : 3.15 mm BL : 2 years | PC21AE / AF  6 3/4x8"  Height : 3.15 mm BL : 2 years | PC21J  6 3/4x8"  Height : 3.15 mm BL : 3 years | | | | |
| | Date | PC22 6 3/4x8"  Height : 4.15 mm BL : 3 years | PC32 10 1/2"  Height : 4.15 mm BL : 3 years | Day - Date | PC23 6 3/4x8"  Height : 4.15 mm BL : 3 years | PC33 10 1/2"  Height : 4.15 mm BL : 3 years | Sun & Moon | PC29 6 3/4x8"  Height : 4.15 mm BL : 3 years |



Website : www.timemodule.com
Email : tmi_mvt@seiko-mfg.hk

SEIKO Manufacturing (H.K.) Ltd.

4-5/F., Wyler Centre 2, 200 Tai Lin Pai Rd., Kwai Chung, N.T., Hong Kong
Telephone: (852) 2494-5111 Direct: (852) 2429-7979 Facsimile: (852) 2420-6992

| | |
|-----------------------------|---|
| India Liaison Office | 309, 3rd Floor, Sanghavi Square, M.G. Road, opp. Bank of Baroda, Ghatkopar West, Mumbai-400 086, India Telephone: (91) 22-2515-5285 Facsimile: (91) 22-2515-5284 |
| Japan Office | 26-1, Ginza 1-Chome, Chuo-ku, Tokyo 104-8118, Japan Telephone: (81) 3-3564-4571 |

All of our WATCH MOVEMENTS are manufactured to the high standard of reliability stipulated by **ISO 9001/14001 SERIES**